

Product data sheet

Characteristics

XUK0AKSAL10

Photoelectric sensors XU, XUK, multi, Sn 0...30 m, 12...24 VDC, cable 10 m



Product availability: Non-Stock - Not normally stocked in distribution facility

Price*: 127.00 USD



Main

Range of Product	Telemecanique Photoelectric sensors XU
Series name	General purpose multimode
Electronic sensor type	Photo-electric sensor
Sensor name	XUK
Sensor design	Compact 50 x 50
Detection system	Multimode
Material	Plastic
Type of output signal	Discrete
Supply circuit type	DC
Wiring Technique	3-wire
Discrete output type	PNP or NPN
Discrete output function	1 NO or 1 NC programmable
Electrical connection	Cable
Cable length	32.81 Ft (10 m)
Product Specific Application	-
Emission	Infrared diffuse Infrared diffuse with background suppression Infrared thru beam Red polarised reflex
[Sn] nominal sensing distance	13.12 Ft (4 m) polarised reflex need reflector XUZC50 98.43 Ft (30 m) thru beam need a transmitter XUK0AKSAL10T 0.92 Ft (0.28 m) diffuse with background suppression 2.62 Ft (0.8 m) diffuse

The information provided in this documentation contains general descriptions and/or technical characteristics of the performance of the products contained herein. This documentation is not intended as a substitute for and is not to be used for determining suitability or reliability of these products for specific user applications. It is the duty of any such user or integrator to perform the appropriate and complete risk analysis, evaluation and testing of the products with respect to the relevant specific application or use thereof. Neither Schneider Electric Industries SAS nor any of its affiliates or subsidiaries shall be responsible or liable for misuse of the information contained herein. *Prices are indicative

Complementary

Enclosure Material	PBT
Lens material	PMMA
Maximum sensing distance	114.83 Ft (35 m) thru beam 0.92 Ft (0.28 m) diffuse with background suppression 3.94 Ft (1.2 m) diffuse 18.70 Ft (5.7 m) polarised reflex
Output Type	Solid state
Add on output	With alarm output, <= 50 mA overload and short-circuit protection
Wire insulation material	PvR
Status LED	1 LED green)supply 1 LED red)instability 1 LED yellow)output state
[Us] rated supply voltage	12...24 V DC with reverse polarity protection
Supply voltage limits	10...36 V DC
Switching capacity in mA	<= 100 mA overload and short-circuit protection)
Switching frequency	<= 250 Hz
Maximum voltage drop	<1.5 V closed state)
Current consumption	<= 35 mA no-load
Maximum delay first up	200 Ms
Maximum delay response	2 Ms
Maximum delay recovery	2 Ms
Setting-up	Self-teaching
Maximum Depth	1.97 In (50 mm)
Maximum Height	1.97 In (50 mm)
Maximum Width	0.71 In (18 mm)

Environment

Product Certifications	CSA UL CE
Ambient Air Temperature for Operation	-13...131 °F (-25...55 °C)
Ambient Air Temperature for Storage	-40...158 °F (-40...70 °C)
Vibration resistance	7 gn +/- 1.5 mm 10...55 Hz) IEC 60068-2-6
Shock resistance	30 gn 11 ms) IEC 60068-2-27
IP degree of protection	IP65 double insulation IEC 60529

Ordering and shipping details

Category	22481 - SENSORS, PHOTOELECTRIC
Discount Schedule	DS2
GTIN	03389110565782
Nbr. of units in pkg.	1
Package weight(Lbs)	18.27 Oz (518 g)
Returnability	No
Country of origin	ID

Packing Units

Unit Type of Package 1	PCE
Package 1 Height	2.76 In (7 cm)
Package 1 width	5.51 In (14 cm)
Package 1 Length	5.91 In (15 cm)

Offer Sustainability

Sustainable offer status	Green Premium product
California proposition 65	WARNING: This product can expose you to chemicals including: Diisononyl phthalate (DINP), which is known to the State of California to cause cancer, and Diisodecyl phthalate (DIDP), which is known to the State of California to cause birth defects or other reproductive harm. For more information go to www.P65Warnings.ca.gov
REACH Regulation	REACH Declaration
EU RoHS Directive	Pro-active compliance (Product out of EU RoHS legal scope) EU RoHS Declaration
Mercury free	Yes
RoHS exemption information	Yes
Environmental Disclosure	Product Environmental Profile
Circularity Profile	End Of Life Information

Contractual warranty

Warranty	18 months
----------	-----------

Dimensions

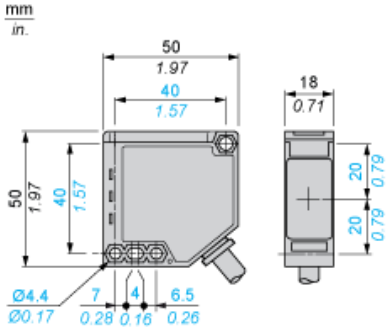

Wiring Schemes

PNP Output

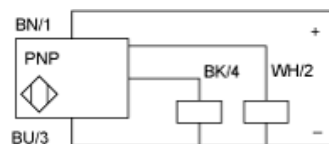

(+) BNBrown
(-) BUBlue
(Output) BK :
(Alarm) WH :

NPN Output

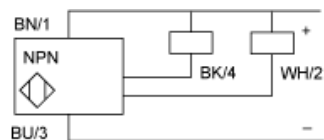

(+) BNBrown
(-) BUBlue
(Output) BK :
(Alarm) WH :

Detection Curves

With Thru-beam Accessory (Thru-beam)

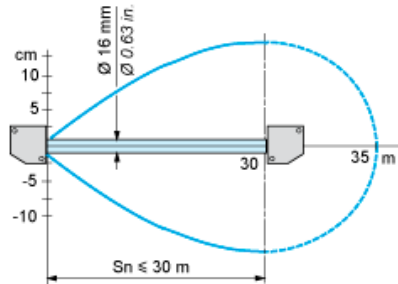

Without Accessory (Diffuse)

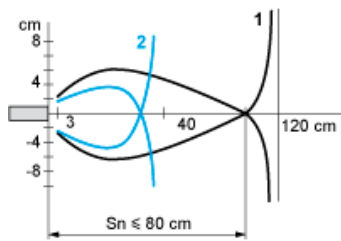

1 : White 90%
2 : Grey 18%
Object 10 x 10 cm

Without Accessory (Diffuse with background suppression)

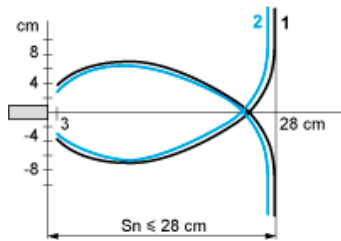

1 : White 90%
2 : Grey 18%
Object 10 x 10 cm

With reflector (Polarised reflex)

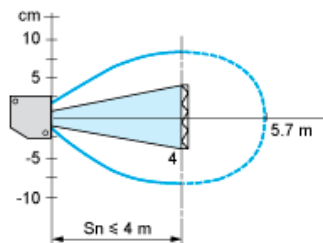

With reflector XUZC50

Variation of Usable Sensing Distance S_u (Without accessory, with adjustable background suppression)

Teach Mode at Minimum

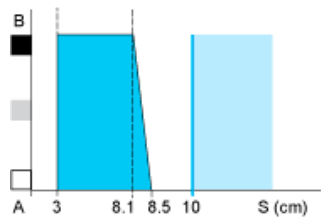

Teach Mode at Maximum

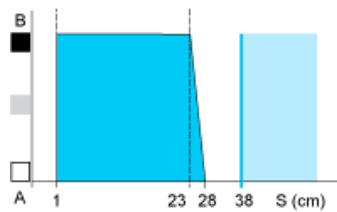

- (1) Black
- (2) Grey
- (3) White
- (4) Sensing range
- (5) Non sensing zone (matt surfaces)

A-B : Object reflection coefficient

- (1) Black 6%
- (2) Grey 18%
- (3) White 90%
- (4) Sensing range
- (5) Non sensing zone (matt surfaces)

Product Life Status : **Commercialised**